



شرکت شمیم صنعت
نمایندگی فروش برند NEO

NE200 SENSORLESS VECTOR TYPE

User Manual

شماره های تماس:

021-88530942

021-88174830

021-88752365

021-88731721



1. Unpacking Inspection

Thank you for choosing our latest NE200 sensorless vector control type frequency inverter. Upon unpacking, please confirm the following: Any damage occurred during transportation; Check whether the model and specifications on the nameplate of inverter are in accordance with your order. If there is any error, please contact us or distributors.

Please read this manual thoroughly before using to make sure our inverter working at best condition.

2. Inverter model description

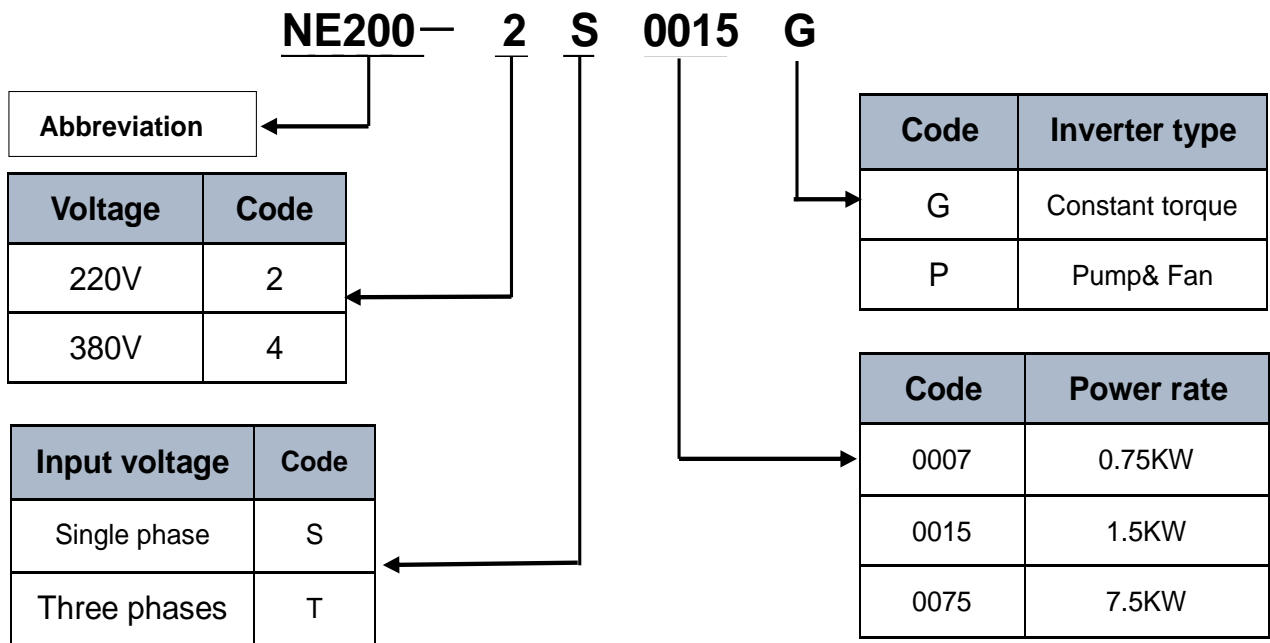
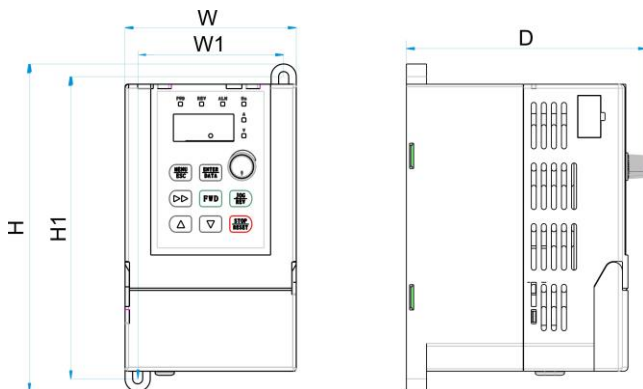

Fig 2-1 Inverter model description

3. Dimensions



Type Number	H(mm)	W(mm)	D(mm)	H1(mm)	W1(mm)	φ (mm)
NE200-2S0002G	162	85	113	144	74	φ 5
NE200-2S 0004G						
NE200-2S 0007G						
NE200-2S 0015G						

4. Specifications

Items		Specifications
Input	Rated voltage/Frequency	Single phase 220V, three phase 200V, three phase 380V; 50Hz/60Hz
	Range	Voltage: $\pm 20\%$ voltage unbalance rate: $< 3\%$; frequency: $\pm 5\%$
Output	Rated voltage	0~200V/220V/380V
	Frequency range	0Hz~500Hz (standard)
	Frequency resolution	0.01Hz
	Overload ability	150% rated current for 1 minute, 180% rated current for 3 seconds
Control function	Modulation modes	Optimized space voltage vector SVPWM modulation
	Control mode	Sensorless vector control (with optimal low frequency dead time compensation)
	Frequency precision	Digital setting: The highest frequency $\times \pm 0.01\%$ Analog setting: The highest frequency $\times \pm 0.2\%$
	Frequency resolution	Digital setting: 0.01Hz; Analog setting: The highest frequency $\times 0.1\%$
	Start frequency	0.40Hz~20.00Hz
	Torque boost	Auto torque boost, manual torque boost 0.1%~30.0%
	V/F curve	Five ways: constant torque V/F curve, 1 kind of user defined V/F curve, 3 kinds of down torque curve (2.0/1.7/1.2 times the power)
	Acc./Dec. curve	Two ways: linear Acc./Dec., S-curve Acc./Dec.; 7 kinds of Acc./Dec. time, time unit (minute/second) optional, max. time: 6000 minutes.
	DC braking	DC braking start frequency: 0~15.00Hz braking time: 0~60.0s braking current: 0~80%
	PID built-in	Easily constitute a close loop control system
	Multi-stage speed running	Multi-stage speed running available through built-in PLC or control terminals
	Textile swing frequency	Swing frequency available with preset and centre frequency adjustable
	Auto voltage regulation (AVR)	When the grid voltage changes, to maintain constant output voltage

Items		Specifications
	Auto energy saving running	Saving energy by auto optimizing V/F curve according to the load
	Auto current limiting	Auto current limiting to prevent frequent over current fault trip
	Multi pump constant water pressure supply	When connect with Yuanshin water supply kit can offer multi-pump constant water pressure supply
	Communication	RS485 standard communication port available, support MODBUS communication protocol of ASCII and RTU, master-slave multi-machine interaction function available
Running function	Running command channel	Control panel : control terminal :serial port :3 channels switchable
	Frequency setting channel	Control panel potentiometer : ▲、▼control panel keys:; function code digital: serial port : terminal up/down: analog voltage: analog current: pulse: combination setting: all channels switchable
	Switch input channel	FWD/REV command: 8channels programmable switch inputs, 35kinds of function can be set separately
	Analog input channel	4~20mA(220V Model): 0-10V: 2 optional analog inputs for 380V Model
Control panel	LED digital display	Display setting frequency, output voltage, output current, etc.
	External meter display	Display output frequency, output current, output voltage, etc.
	Key lock	All the keys can be locked
	Parameter copy	Function code parameters are able to be copied between inverters when use remote control panel
Protection function		Overcurrent protection: overvoltage protection: undervoltage protection: overheating protection: overload protection, etc.
Environment	Environment	Indoors, free from direct sunlight, dust, corrosive gas, oil mist, steam, water dropper salt, etc
	Altitude	Lower than 1000m (derating is necessary above 1000m)
	Ambient temperature	-10℃~+50℃

Items		Specifications
	Humidity	<90%RH, no condensation
	Vibration	Lower than 5.9m/s (0.6g)
	Storage temperature	-20°C~+60°C
Structure	Protection level	IP20 (In the selection of state display unit or the keyboard state)
	Cooling	Forced air cooling
Installation		Wall mounted

Models	Rated output current(A)	Motor power (KW)
NE200 series/Input voltage: 220V single phase		
NE200-2S0004G	3.0	0.4
NE200-2S0007G	4.7	0.75
NE200-2S0015G	7.5	1.5

5. Wire Connection

Security Level	Safety Precautions
 Attention	<ul style="list-style-type: none"> ◆ Before wiring, please ensure the power has been removed and be wait for at least 10minutes. ◆ Please do not connect AC power to output terminals U/V/W. ◆ To ensure the safety, the inverter and motor should be safety grounding. It is necessary to use copper wire above 3.5mmas ground wire, grounding resistance less than 10Ω. ◆ The inverter has gone through voltage withstand test in factory, please do not make it again. ◆ Solenoid switch or absorbing devices, such as ICEL, is prohibited to connect inverter output. ◆ To provide input over current protection and for convenience in maintenance, the inverter should be connected to AC power

Security Level	Safety Precautions
	<p>through circuit breaker.</p> <ul style="list-style-type: none"> ◆ Please use twisted wire or shielded wire above 0.75mm for the wiring of relay input/output loop (X1~X6, FWD, REV, OC, DO).One end of shielding layer suspended, and the other side connected to PE grounding terminal of inverter, wiring length less than 50m .
<div style="text-align: center;">  <p>Attention</p> </div>	<ul style="list-style-type: none"> ◆ The cover can be removed only when the power is switched off, all the LEDs on the panel are off and waiting at least for 10 minutes. ◆ Wiring work can be performed only when the DC voltage between P+ and P- terminals is lower than 36V. ◆ Wiring work can only be done by trained or professional personnel. ◆ Before usage, check whether the mains voltage meets the requirement of inverter input voltage.

6. Installation

6.1 Environment Requirements

- ◆ Please mount inside a well-ventilated location. The ambient temperature is required to be within the range of -10 ~40°C. If the temperature is higher than 40 °C, the inverter should be derated, at the same time the ventilation and heat dissipation should be enhanced.
- ◆ Be away from the location full of dust or metal powder, and mount in the location free of direct sunlight.
- ◆ Mount in the location free of corrosive gas or combustible gas.
- ◆ Humidity should be lower than 95% with no dew condensation.
- ◆ Mount in the location where vibration is less than 5.9m/s² (0.6G) .

- ◆ Please try to keep the inverter away from EMI source and other electronic devices which are sensitive to EMI.

6.2 Mounting Space and Direction

- ◆ Generally in vertical way.
- ◆ For the requirements on mounting space and distance, refer to Fig.3-1.
- ◆ When several inverters are installed in one cabinet, they should be mounted in parallel with special incoming and out coming ventilation and special fans. When two inverters are mounted up and down, an air flow diverting plate should be fixed as shown in Fig.3-2 to ensure good heat dissipation.

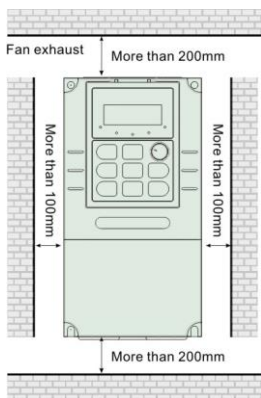

Fig.6-1 Mounting space and distance

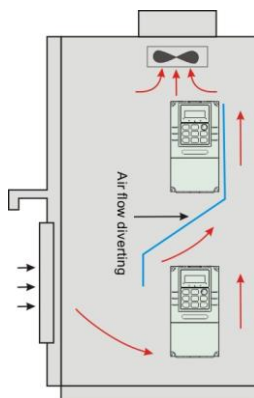
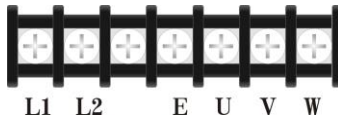
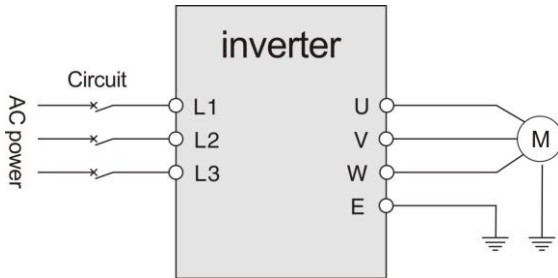

Fig.6-2 Mounting of multiple inverters

7. Standard Wiring Diagram



Terminal name	Function
L1、L2	220V 1-phase Input terminals
U、V、W	220V 3-phase Output terminals
E	wiring terminals

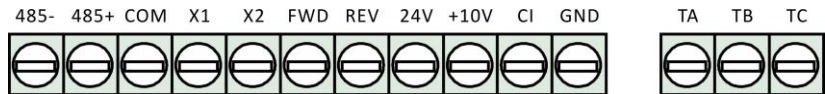

Fig. 7-1 Single-phase control board terminal arrangement sequence diagram

Sort	Terminal	Name	Function	Specification
Commu- -nication	485+	RS485 interface	RS485 differential signal positive terminal	Twisted or shielded wire needed
	485-		RS485 differential signal negative terminal	

Sort	Terminal	Name	Function	Specification
Relay output terminal	TA	Relay output terminal TA	Can be defined as multifunctional Relay output terminal by programming, refer to Chapter 6.5 P4.12, P4.13	TA-TC: NC, TA-TB: Normally open contact capacity AC250V/2A (COS Φ =1) AC250V/1A (COS Φ =0.4) DC30V/1A
	TB	Relay output terminal TB		
	TC	Relay output terminal TC		
Operation control terminal	FWD	Forward running	Refer to chapter 6.5 P4.08	Couple isolated input Input resistance: 2K Ω
	REV	Reverse running		
Multifunctional input terminal	X1	Multifunctional input terminal 1		Optical coupling isolation, compatible dual polarity input Input impedance: R=2 K Ω Max input frequency: 200Hz Input voltage range: 9~30V
	X2	Multifunctional input terminal 2		
Power	24V	+24V common terminal	Supply +24V power (negative terminal: COM)	
	10V	+10V power	Supply +10V power (negative terminal: GND)	Max. output current: 50mA
	GND	+10V common terminal	Grounding of analog signal and +10V power source	Terminal COM and GND are isolated inside
	COM	+24V common terminal	Digital signal input, output common terminal	

8. Basic Wiring Diagram

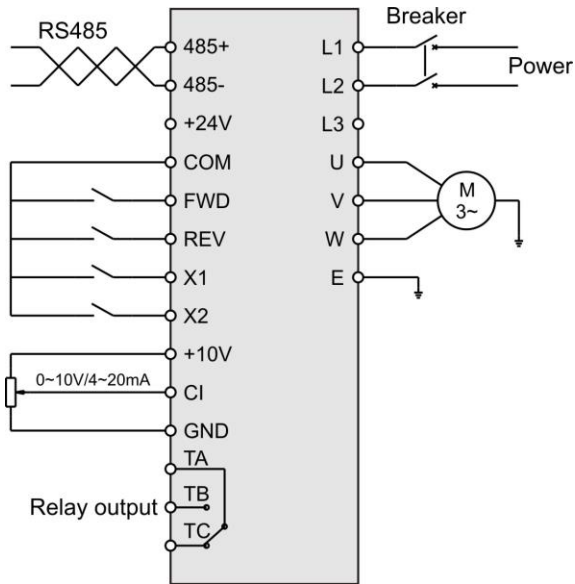

Fig. 8-01

NE200-2S0002G(220V) NE200-2S0004G(220V)

NE200-2S0007G(220V) NE200-2S0015G(220V)

9. Keypad introduce

9.1 Keypad interface

The operation panel and control terminals of the inverter can control the starting, speed regulation, shutdown, braking, operating parameter setting and peripheral equipment of the motor. The operation panel is shown in Figure 9-1.

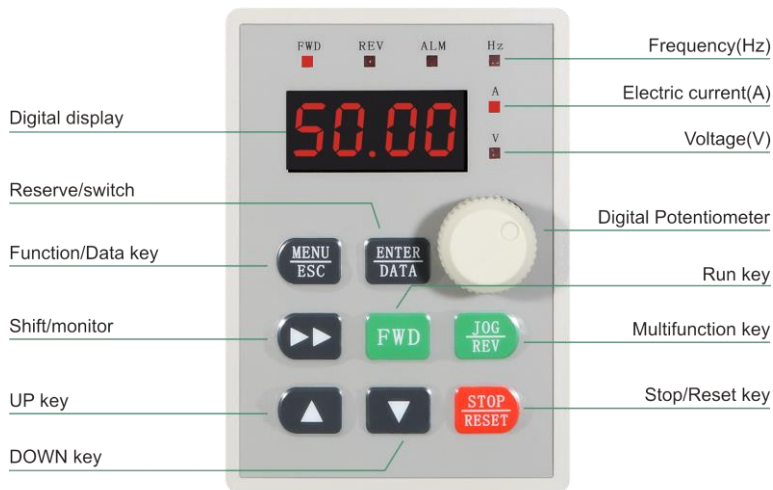









Fig. 9-01 Control panel diagram

9.2 Keypad Function description

Name	Description		
Status light	RUN	When the light is on, the inverter is in the running state; when the light is off, the inverter is in the stop state.	
	LOCAL	○ LOCAL/REMOT: Light off	Indicates that the inverter is in the stop state
		● LOCAL/REMOT: Twinkling	Indicates the communication start and stop control mode
		● LOCAL/REMOT: Constant on	Indicates the terminal start and stop control mode

Name	Description		
Unit indicator	Indicates the unit currently displayed on the keyboard		
	Hz		Frequency unit
	A		Current unit
V		Voltage unit	

Name	Description					
Digital Display Area	There are 4 LED digital tubes on the operation panel of the inverter, which display various monitoring data such as setting frequency, output frequency and alarm codes.					
	Digital Display	Corresponding Letter	Digital Display	Corresponding Letter	Digital Display	Corresponding Letter
	0	0	1	1	2	2
	3	3	4	4	5	5
	6	6	7	7	8	8
	9	9	A	a	B	b
	C	C	D	d	E	E
	F	F	H	F	I	I
	L	L	N	N	n	n
	O	o	P	P	R	r
	S	S	T	t	U	U
U	v	.	.	-	-	
Digital Potentiometer		Turn left = decrement, turn right = increment . Press potentiometer= button.				

Name	Description		
Operation Button		Running	Press this button for running
		Multi-function	Default=Reverse , can change funtion via P7.00
		Stop/Reset	When VFD at normal running , press this button to stop Inverter as pre-setting way. When VFD has fault, press this button to reset the inverter back to normal status.
		Menu/Data	Enter or exit programming status
		Increment	Data or function code increment
		Decrement	Data or function code decrement
		Move/Switch	At edit status, can shoose the data want to change; At other status, can switch to monitoring data display.
		Save/Switch	At edit status, to enter next level menu or save the function code data.

10. Standard Function Parameters

10.1 Symbol Description

“○” : The parameter can be modified when the AC drive is in either stop or running state. “×” : The parameter can not be modified when the AC drive is in the running state.

“*”: The parameter is factory parameter and can not be modified.

10.2 Function Code Table

Func Code	Name	Range	Min Unit	Factory Default	Change
P0 Group: Basic running function parameter					
P0.00	Control mode selection	0: V/F Control 1: Senseless vector control	1	0	○
P0.01	Frequency given channel selection	0: Analog potentiometer on control panel 1: ▲、▼key on control panel 2: Digital setting 1,control panel given 3: Digital setting 2, UP/DOWN terminal given 4: Digital setting 3, serial port given 5: VI analog given (VI-GND) 6: CI analog given(CI-GND) 7: Pulse terminal given(PULSE) 8: Combination given (refer to P3.00)	1	0	○
P0.02	Running Frequency Digital Setting	P0.19lower limit freq.-P0.20upper limit freq.	0.01Hz	50.00Hz	○
P0.03	Running command mode selection	0: Control panel mode 1: Terminal control mode 2: Serial port control mode	1	0	○
P0.04	Running direction setting	Unit's place: 0: Forward 1:Reverse Ten's place: 0:REV allowed REV 1:REV prohibited	1	10	○
P0.05	FWD/REV dead	0.0~120.0s	0.1s	0.1s	○

Func Code	Name	Range	Min Unit	Factory Default	Change
	time				
P0.06	Max output freq.	50.00Hz~500.00Hz	0.01Hz	50.00Hz	×
P0.07	Basic running freq	1.00Hz~500.00Hz	0.01Hz	50.00Hz	×
P0.08	Max output voltage	1~480V	1V	inverter rated voltage	×
P0.09	Torque boost	0.0%~30.0%	0.1%	2.0%	×
P0.10	Torque boost cut-off freq.	0.00Hz~Basic running freq.P0.07	0.00	50.00Hz	○
P0.11	Torque boost mode	0: Manual 1: Auto	1	0	○
P0.12	Carrier freq	1.0K~14.0K	0.1K	8.0K	×
P0.13	Acc/Dec mode selection	0: Linear Acc/Dec 1: S Curve Acc/Ced	1	0	×
P0.14	Time of S curve start stage	10.0%~50.0% (Acc/Dec time) P0.14+P0.15 ≦ 90%	0.1%	20.0%	○
P0.15	Time of S curve ascent stage	10.0%~80.0% (Acc/Dec time) P0.14+P0.15 ≦ 90%	0.1%	60.0%	○
P0.16	Acc/Dec time unit	0: Second 1: Minute	0	0	×
P0.17	Acc time 1	0.1~6000.0	0.1	20.0	○
P0.18	Dec time 1	0.1~6000.0	0.1	20.0	○
P0.19	Upper limit freq.	Lower limit freq. ~Max output freq.P0.06	0.01Hz	50.00Hz	×
P0.20	Lower limit freq.	0.00Hz~Upper limit freq.	0.01Hz	0.00Hz	×
P0.21	Lower limit freq. Running mode	0: Running at lower limit freq 1: Stopping	1	0	×
P0.22	V/F curve setting	0: Constant torque curve 1: Reduced torque curve 1 (1.2 times the power) 2: Reduced torque curve 2 (1.7 times the power) 3: Reduced torque curve 3 (2.0 times the power)	1	0	×

Func Code	Name	Range	Min Unit	Factory Default	Change
		4: Customized V/F curve			
P0.23	V/F Freq.valueF3	P0.25 ~ P0.07 Basic running freq.	0.01Hz	0.00Hz	×
P0.24	V/F Volt.valueV3	P0.26 ~ 100.0%	0.1%	0.0%	×
P0.25	V/F Freq.valueF2	P0.27 ~ P0.23	0.01Hz	0.00Hz	×
P0.26	V/F Volt.valueV2	P0.28 ~ P0.24	0.1%	0.0%	×
P0.27	V/F Freq.valueF1	0.00~P0.25	0.01Hz	0.00Hz	×
P0.28	V/F Volt.valueV1	0 ~ P0.26	0.1%	0.0%	×
P1 Group: Frequency setting function parameter					
P1.00	Analog filtering time constant	0.01~30.00s	0.01s	0.20s	○
P1.01	VI channel gains	0.01~9.99	0.01	1.00	○
P1.02	VI min given	0.00~P1.04	0.01Hz	0.00V	○
P1.03	Corresponding freq. to VI min given	0.00~Upper limit freq.	0.01Hz	0.00Hz	○
P1.04	VI max given	P1.04~10.00V	0.01V	10.00V	○
P1.05	Corresponding freq to VI max given	0.00~Upper limit freq.	0.01Hz	50.00Hz	○
P1.06	CI channel gains	0.01~ 9.99	0.01	1.00	○
P1.07	CI min given	0.00~ P1.09	0.01V	0.00V	○
P1.08	Corresponding freq. to CI min given	0.00~Upper limit freq	0.01Hz	0.00Hz	○
P1.09	CI max given	P1.07 ~10.00V	0.01V	10.00V	○
P1.10	Corresponding freq. to CI max given	0.00~Upper limit freq	0.01Hz	50.00Hz	○
P1.11	Max input pulse freq	0.1~20.0K	0.1K	10.0K	○
P1.12	Pulse min given	0.0~P1.14(Pulse max given)	0.1K	0.0K	○
P1.13	Corresponding freq. to pulse min given	0.00~Upper limit freq	0.01Hz	0.00Hz	○
P1.14	Pulse max given	P1.12(Pulse min given)~P1.11(Max input pulse freq.)	0.1K	10.0K	○
P1.15	Corresponding freq.	0.00~Upper limit freq	0.01Hz	50.00Hz	○

Func Code	Name	Range	Min Unit	Factory Default	Change
	to pulse max given				
P2 Group: Start/Brake function parameter					
P2.00	Start running mode	0: Start from start freq. 1: Brake first, then start from start freq. 2: Track speed, then start.	1	0	×
P2.01	Start freq.	0.40~20.00Hz	0.01Hz	0.50Hz	○
P2.02	Start freq. running duration	0.0~30.0s	0.1s	0.0s	○
P2.03	DC brake current as start	0~15%	1%	0%	○
P2.04	DC brake time as start	0.0~60.0s	0.1s	0.0s	○
P2.05	Stop mode	0: Dec 1: Free Stop 2: Dec+DC brake	1	0	×
P2.06	Start freq. of DC brake as stop	0.0~15.00Hz	0.0Hz	3.00Hz	○
P2.07	DC brake time as stop	0.0~60.0s	0.1s	0.0s	○
P2.08	DC brake current as stop	0~15%	1%	0%	○
P3 Group :Auxiliary running parameter					
P3.00	Freq. control channel combination	0: VI+CI 1: VI-CI 2: External pulse given+VI+control panel▲、▼key given 3: External pulse given-VI-control panel▲、▼key given 4: External pulse given+CI 5: External pulse given-CI 6: RS485 given+VI+control panel▲、▼key given 7: RS485 given-VI-control panel▲、▼key given 8: RS485 given+CI+control panel▲、▼key given	1	0	×

Func Code	Name	Range	Min Unit	Factory Default	Change
		▼key given 9: RS485 given—CI—control panel▲、 ▼key given 10: RS485 given+CI+ External pulse given 11: RS485 given—CI— External pulse given 12: RS485 given+VI+ External pulse given 13: RS485 given—VI— External pulse given 14: VI+CI+control panel▲、 ▼key given +digital given (P0.02) 15: VI+CI—control panel▲、 ▼key given +digital given (P0.02) 16: MAX (VI, CI) 17: MIN (VI, CI) 18: MAX (VI, CI, PULSE) 19: MIN (VI, CI, PULSE) 20: VI, CI(Availability except 0,VI prior) 21: VI+Terminal UP/DOWN 22: CI+Terminal UP/DOWN 23: RS485 setting + panel analog potentiometer fine tuning 24: RS485 setting-panel analog potentiometer 25: RS485 setting + VCI 26: RS485 setting-VCI 27: RS485 setting + CCI 28: RS485 setting-CCI 29: VI + analog potentiometer fine tuning 30: Fine adjustment of CI + analog potentiometer fine tuning 31: VI + analog potentiometer			

Func Code	Name	Range	Min Unit	Factory Default	Change
		32: VI-analog potentiometer 33: CI + analog potentiometer 34: CI-analog potentiometer 35: RS485 setting + UPDOWN terminal fine tuning			
P3.01	Parameter initialization setting	LED unit's place: 0: All parameters are allowed to be revised. 1: All parameters are not allowed to be revised except this parameter itself. 2: All parameters are not allowed to be revised except P0.02 parameter and this parameter itself LED ten's place: 0: Inaction 1: Factory default reset 2: Clear history fault record	1	0	×
P3.02	Reserved	----	---	---	×
P3.03	Auto energy save running	0: Inaction 1: Action	1	0	×
P3.04	AVR function	0: Inaction 1: Always action 2: Inaction only in Dec	1	0	×
P3.05	Slip freq. compensation	0~150%	1%	0%	×
P3.06	JOG running freq.	0.10~50.00Hz	0.01Hz	5.00Hz	○
P3.07	JOG Acc time	0.1~60.0s	0.1s	20.0s	○
P3.08	JOG Dec time	0.1~60.0s	0.1s	20.0s	○
P3.09	Communication configuration	LED unit's place: baud rate selection 0: 1200BPS 1: 2400BPS 2: 4800BPS 3: 9600BPS 4: 19200BPS 5: 38400BPS LED ten's place: data format	1	005	×

Func Code	Name	Range	Min Unit	Factory Default	Change
		0: 1-7-2 Format, without check 1: 1-7-1 Format, odd parity check 2: 1-7-1 Format, even parity check 3: 1-8-2 Format, without check 4: 1-8-1 Format, odd parity check 5: 1-8-1 Format, even parity check 6: 1-8-1 Format, without check LED hundred's place: communication mode 0: MODBUS, ASCII Mode 1: MODBUS, RTU Mode			
P3.10	Local address	0~248 0:Broadcast address 248:Host address	1	1	×
P3.11	Communication overtime detection time	0.0~1000.0s 0.0: Function invalid	0.1s	0.0s	×
P3.12	Local response delay	0~1000ms	1	5ms	×
P3.13	Multi-running running proportion	0.01~1.00	0.01	1.00	×
P3.14	Acc time2	0.1~6000.0	0.1	20.0	○
P3.15	Dec time2	0.1~6000.0	0.1	20.0	○
P3.16	Acc time3	0.1~6000.0	0.1	20.0	○
P3.17	Dec time3	0.1~6000.0	0.1	20.0	○
P3.18	Acc time4	0.1~6000.0	0.1	20.0	○
P3.19	Dec time4	0.1~6000.0	0.1	20.0	○
P3.20	Acc time5	0.1~6000.0	0.1	20.0	○
P3.21	Dec time5	0.1~6000.0	0.1	20.0	○
P3.22	Acc time6	0.1~6000.0	0.1	20.0	○
P3.23	Dec time6	0.1~6000.0	0.1	20.0	○
P3.24	Acc time7	0.1~6000.0	0.1	20.0	○
P3.25	Dec time7	0.1~6000.0	0.1	20.0	○
P3.26	Multi-stage freq.1	Lower limit freq.~Upper limit freq.	0.01Hz	5.00Hz	○
P3.27	Multi-stage freq.2	Lower limit freq.~Upper limit freq.	0.01Hz	10.00Hz	○
P3.28	Multi-stage freq.3	Lower limit freq.~Upper limit freq.	0.01Hz	20.00Hz	○

Func Code	Name	Range	Min Unit	Factory Default	Change
P3.29	Multi-stage freq.4	Lower limit freq.~Upper limit freq.	0.01Hz	30.00Hz	○
P3.30	Multi-stage freq.5	Lower limit freq.~Upper limit freq.	0.01Hz	40.00Hz	○
P3.31	Multi-stage freq.6	Lower limit freq.~Upper limit freq.	0.01Hz	45.00Hz	○
P3.32	Multi-stage freq.7	Lower limit freq.~Upper limit freq.	0.01Hz	50.00Hz	○
P3.33	Jump freq.1	0.00~500.00Hz	0.01Hz	0.00Hz	×
P3.34	Jump freq.1range	0.00~30.00Hz	0.01Hz	0.00Hz	×
P3.35	Jump freq.2	0.00~500.00Hz	0.01Hz	0.00Hz	×
P3.36	Jump freq.2range	0.00~30.00Hz	0.01Hz	0.00Hz	×
P3.37	Reserved	0000~9999	1	0000	×
P3.38	Zero frequency DC braking voltage	0.0%~15.0%	0.1%	0.0%	×
P3.39	Set running time	0~65.535K hour	0.001K	0.000K	○
P3.40	Total running time	0~65.535K hour	0.001K	0.000K	*
P3.41	Slow down and start wait time	00.0~60.0	0.1s	02.0 s	○
P3.42	Inspection speed and start the maximum output current level	00.0~150.0%	0.1%	100.0%	○
P3.43	Running display parameter selection1	00~15	1	00	○
P3.44	Stop display parameter selection2	00~15	1	00	○
P3.45	No unit display coefficient	0.1~60.0	0.1	29.0	○
P3.46	JOG/REV Switching control	0: Select the JOG point operation 1: Select the REV reverse operation	1	0	×
P4 Group: Terminal control function parameter					
P4.00	Input terminal X1 function selection	0: Idle terminal 1: Multi-stage speed control terminal 1 2: Multi-stage speed control terminal 2 3: Multi-stage speed control terminal 3 4: External FWD JOG control input	1	0	×

Func Code	Name	Range	Min Unit	Factory Default	Change
		5: External REV JOG control input 6: Acc/Dec time terminal 1 7: Acc/Dec time terminal 2 8: Acc/Dec time terminal 3 9: 3-wire control 10: Free stop input (FRS) 11: External stop command 12: Stopping DC brake input command DB 13: Inverter running prohibited 14: Freq. increase command(UP) 15: Freq. decrease command(DOWN) 16: Acc/Dec prohibited command 17: External reset input (clear fault) 18: Peripheral equipment fault input (normally open) 19: Freq. control channel selection 1 20: Freq. control channel selection 2 21: Freq. control channel selection 3 22: Command switched to terminal 23: Running command control mode selection 1 24: Running command control mode selection 2 25: Swing frequency selection 26: Swing frequency running reset 27: Close loop invalid 28: Simple PLC pause running command 29: PLC invalid 30: PLC Reset in stopping state 31: Freq. switch to CI 32: Counter trig signal input 33: Counter clear input 34: External interrupt input 35: Pulse freq. input (only valid for X6)			
P4.01	Input terminal X2	Ditto	1	0	×

Func Code	Name	Range	Min Unit	Factory Default	Change
	function selection				
P4.08	FWD/REV running mode selection	0: 2-wire control mode 1 1: 2-wire control mode 2 2: 3-wire control mode 1 3: 3-wire control mode 2	1	0	×
P4.09	UP/DN Rate	0.01—99.99Hz/s	0.01	1.00Hz/s	○
P4.12	Relay TA/TB/TC output selection	Ditto	1	15	×
P4.14	Freq. arrival detection range	0.00~400.00Hz	0.01Hz	5.00Hz	○
P4.15	FDT1 (freq. level)	0.00~Upper limit freq	0.01Hz	10.00Hz	○
P4.16	FDT1 lag	0.00~50.00Hz	0.01Hz	1.00Hz	○
P4.21	DO output terminal function selection	unit's place : 0: Output freq.(0~upper limit freq.) 1: Output current(0~2 times motor rated current) 2: Output voltage(0~1.2 times inverter rated voltage) 3: Bus bar voltage (0~800V) 4: PID given 5: PID feedback 6: VI (0~10V) 7: CI(0~10V/4~20mA)	1	0	○
P4.22	DO max pulse output freq.	0.1K~20.0K (max 20KHz)	0.1KHz	10.0KHz	○
P4.23	Set counts given	F4.20~9999	1	0	○
P4.24	Specified counts given	0~F4.19	1	0	○
P4.25	Overload pre-alarm detection level	20%~200%	1	130%	○
P4.26	Overload pre-alarm delay time	0.0~20.0s	0.1s	5.0s	○
P5 Group: Protection function parameter					
P5.00	Motor overload protection	0: Stop outputting 1: Inaction	1	0	×

Func Code	Name	Range	Min Unit	Factory Default	Change
	mode selection				
P5.01	Motor overload protection coefficient	20~120%	1	100%	×
P5.02	Overvoltage stall Selection	0: Prohibited 1: Allowed	1	1	×
P5.03	Overvoltage stall point	380V: 120~150% 220V: 110~130%	1%	140% 120%	○
P5.04	Auto current limit level	110%~200%	1%	150%	×
P5.05	Freq. drop rate during current limit	0.00~99.99Hz/s	0.01Hz/s	10.00Hz/s	○
P5.06	Auto current limit mode selection	0: Constant speed invalid 1: Constant speed valid Note: Acc/Dec valid	1	1	×
P5.07	Restart setting after power failure	0: Inaction 1: Action	1	0	×
P5.08	Restart waiting time after power failure	0.0~10.0s	0.1s	0.5s	×
P5.09	Fault self-recovery times	0~10 0: Self-recovery invalid Note: Self-recovery invalid in overload or overheat	1	0	×
P5.10	Self-recovery interval time	0.5~20.0s	0.1s	5.0s	×
P6 Group: Fault record function parameter					
P6.00	Last fault record	Last fault record	1	0	*
P6.01	Output freq. in last fault	Output freq. in last fault	0.01Hz	0	*
P6.02	Set freq. in last fault	Set freq. in last fault	0.01Hz	0	*
P6.03	Output current in last fault	Output current in last fault	0.1A	0	*
P6.04	Set freq. in last fault	Set freq. in last fault	1V	0	*
P6.05	Output current in last fault	Output current in last fault	1V	0	*

Func Code	Name	Range	Min Unit	Factory Default	Change
P6.06	Output voltage in last fault	Output voltage in last fault	10C	0	*
P6.07	Last 2 fault record	Last 2 fault record	1	0	*
P6.08	Last 3 fault record	Last 3 fault record	1	0	*
P6.09	Last 4 fault record	Last 4 fault record	1	0	*
P6.10	Last 5 fault record	Last 5 fault record	1	0	*
P6.11	Last 6 fault record	Last 6 fault record	1	0	*
P7 Group: Close loop running control function parameter					
P7.00	Close loop running control selection	0: Invalid 1: Valid	1	0	×
P7.01	Close loop given channel selection	0: P7.05 Digital given + panel▲、▼Fine tuning 1: VI analog 0~10V voltage given 2: CI analog 0~10V given 3: Panel analog potentiometer given 4: RS485 communication given 5: Pulse input given 6: CI simulation4~20mA Current setting	1	0	×
P7.02	Feedback channel selection	0: VI analog 0~10V input voltage 1: CI analog input (0~10V/0~20mA) 2: VI+CI 3: VI-CI 4: Min {VI, CI} 5: Max {VI, CI} 6: CI analog input (4~20mA)	1	0	×
P7.03	Given channel filtering time constant	0.01~50.00s	0.01s	0.50s	○
P7.04	Feedback channel filtering time constant	0.01~50.00s	0.01s	0.50s	○
P7.05	Given value digital setting	0.001~20.000Mpa	0.001Mpa	0.000Mpa	×
P7.06	Close loop adjustment characteristics	0: Positive effect 1: Negative effect	1	0	○

Func Code	Name	Range	Min Unit	Factory Default	Change
P7.07	Feedback channel gain	0.01~10.00	0.01	1.00	○
P7.08	Lower pressure limit	0.001~P7.09	0.001	0.001	○
P7.09	Upper pressure limit	P7.08~P7.27	0.001	1.000	○
P7.10	PID Controller structure	0: Proportional control 1: Integral control 2: Proportional integral control 3: Proportional, integral and differential control	1	1	×
P7.11	Proportional gain KP	0.00~5.00	0.01	0.50	○
P7.12	Integral time constant	0.1~100.0s	0.1	10.0s	○
P7.13	Differential gain	0.0~5.0	0.1	0.0	×
P7.14	Sampling period	0.01~1.00s	0.01	0.10	○
P7.15	Tolerance limit	0.0~20.0%	0.1%	0.0%	○
P7.16	PID Feedback disconnected detection threshold	0~Upper limit freq	0.01Hz	0.00Hz	○
P7.17	PID Feedback disconnected action selection	0~3	1	0	○
P7.18	PID Feedback disconnected operation delay time	0.01~5.00s	0.01s	1.00s	○
P7.19	Pressure level.	0.001~P7.20	0.001Mpa	0.001Mpa	○
P7.20	Sleep pressure level	P7.19~P7.27	0.001Mpa	1.000Mpa	○
P7.21	Sleep level continuous time	0~250s	1s	10s	○
P7.22	Sleep frequency	0.00~400.0Hz	0.01Hz	20.00Hz	○
P7.23	Sleep frequency continuous time	0~250s	1s	10s	○
P7.24	Low alarm limit pressure	0.001~P7.25	0.001Mpa	0.001Mpa	○

Func Code	Name	Range	Min Unit	Factory Default	Change
P7.25	The alarm limit pressure	P7.24~P7.27	0.001Mpa	1.000Mpa	○
P7.26	Constant pressure water supply mode	0: Choosing not to constant pressure water supply mode 1: With a constant pressure water supply mode 2: A two constant pressure water supply mode 3: A three constant pressure water supply mode 4: A four constant pressure water supply mode	1	0	×
P7.27	Remote pressure gauge range	0.001~20.000Mpa	0.001Mpa	1.000Mpa	○
P7.28	Multi pump operation mode	0: Fixed sequence switch 1: Timing of the rotation	1	0	○
P7.29	Rotation in timed intervals	0.5~100.0H	0.1H	5.0H	○
P7.30	Pump switching judgment time	0.1~1000.0s	0.1s	300.0s	×
P7.31	Electromagnetic switching delay time	0.1~10.0s	0.1s	0.5s	×
P7.32	PID Control of positive and negative role and feedback pressure error polarity	unit's place: 0: PID Control action 1: PID Control reaction ten's place: 0: Feedback pressure less than the actual pressure 1: Feedback pressure is greater than the actual pressure	1	00	×
P7.33	Feedback error of pressure adjustment coefficient	0.001~20.000Mpa	0.001Mpa	0.000Mpa	×
P7.34	Closed loop of preset frequency	Range: 0~Upper limit freq	0.00Hz	0.00Hz	×
P7.35	Closed loop of	Range: 0.0~200.0s	0.1s	0.0s	×

Func Code	Name	Range	Min Unit	Factory Default	Change
	preset frequency holding time				
P8 Group PLC running parameter					
P8.00	PLC running mode selection	0000~1113 LED unit 's place: mode selection 0: Inaction 1: Stop after single cycle 2: Running at final freq after single cycle 3: Continuous cycle LED ten's place: restart mode selection 0: Restart from the first stage 1: Restart from the freq. of break stage 2: Restart from the running. of break stage LED hundred's place: parameter save mode selection 0: No save 1: Save LED thousand's place: running time unit 0: Second 1:minute	1	0000	×
P8.01	Stage 1 setting	000~621 LED unit 's place: freq setting 0: Multi-stage freq i (i=1~7) 1: Freq. defined by P0.01 function code LED ten's place: direction selection 0: Forward 1: Reverse 2: Controlled by running command LED hundred's place: Acc/Dec time selection 0: Acc/Dec time 1 1: Acc/Dec time 2 2: Acc/Dec time 3 3: Acc/Dec time 4	1	000	○

Func Code	Name	Range	Min Unit	Factory Default	Change
		4: Acc/Dec time 5 5: Acc/Dec time 6 6: Acc/Dec time 7			
P8.02	Stage 1 running time	0.1~6000.0	0.1	10.0	○
P8.03	Stage 2 setting	000~621	1	000	○
P8.04	Stage 2 running time	0.1~6000.0	0.1	10.0	○
P8.05	Stage 3 setting	000~621	1	000	○
P8.06	Stage 3 running time	0.1~6000.0	0.1	10.0	○
P8.07	Stage 4 setting	000~621	1	000	○
P8.08	Stage 4 running time	0.1~6000.0	0.1	10.0	○
P8.09	Stage 5 setting	000~621	1	000	○
P8.10	Stage 5 running time	0.1~6000.0	0.1	10.0	○
P8.11	Stage 6 setting	000~621	1	000	○
P8.12	Stage 6 running time	0.1~6000.0	0.1	10.0	○
P8.13	Stage 7 setting	000~621	1	000	○
P8.14	Stage 7 running time	0.1~6000.0	0.1	10.0	○
P9 Group Swing frequency function parameter					
P9.00	Swing freq. selection	0: Inaction 1: Action	1	0	×
P9.01	Swing freq. running mode	0000~11 LED unit's place: start mode 0: Auto start 1: Manual start by terminal LED ten's place: swing amplitude control 0: Variable swing amplitude 1: Fixed swing amplitude	1	00	×
P9.02	Preset swing freq.	0.00~500.00Hz	0.01Hz	0.00Hz	○
P9.03	Preset swing freq. waiting time	0.0~3600.0s	0.1s	0.0s	○
P9.04	Swing amplitude	0.0~50.0%	0.1%	0.0%	○
P9.05	Kick freq.	0.0~50.0%	0.1%	0.0%	○
P9.06	Swing freq. cycle	0.1~999.9s	0.1s	10.0s	○
P9.07	delta wave ascent time	0.0~98.0%	0.1%	50.0%	○

Func Code	Name	Range	Min Unit	Factory Default	Change
P9.08	Fan control selection	0: Inverter operation of fan operation 1: Power on the wind turbine operation	1	0	○
P9.09	Reserved	0000~9999	1	0000	○
P9.11	Overpressure protection threshold value	0~780V	1V	780V	○
P9.13	G、P Model set	0、1	1	0	○
P9.14	User password	1~9999	1	0	○
PF Group: Factory function parameter					
PF.00~ PF.10	Reserved	—	—	—	—

10.3 State Monitoring Parameter Table

B-Monitoring: function parameter					
Func Code	Name	Range	Min Unit	Factory default	Change
b-00	Output freq	Present output freq	0.01Hz		*
b-01	Set freq.	Present set freq.	0.01Hz		*
b-02	Output voltage	Effective value of present output voltage	1V		*
b-03	Output current	Effective value of present output current	0.1A		*
b-04	Bus bar voltage	Present DC bus bar voltage	1V		*
b-05	Module temperature	IGBT heat sink temperature	10C		*
b-06	Motor speed	Present motor speed	1r/min		*
b-07	Running time	One continuous running time	1H		*
b-08	Input/output terminal state	Input/output terminal state	—		*
b-09	Analog input VI	Analog input VI value	0.01V		*
b-10	Analog input CI	Analog input CI value	0.01V		*
b-11	External pulse input	External pulse width input value	1ms		*
b-12	Inverter rated current	Inverter rated current	0.1A		*

B-Monitoring: function parameter					
Func Code	Name	Range	Min Unit	Factory default	Change
b-13	Inverter rated voltage	Inverter rated voltage	1V		*
b-14	Set pressure	Water supply control when the set pressure of the pipeline	0.001Mpa		
b-15	Feedback pressure	Water supply control feedback pipeline pressure	0.001Mpa		
b-16	No unit display	No unit display	1		



11. Fault Diagnosis and Processing





11.1 Failure phenomena and countermeasures

When an abnormality occurs in the inverter, the LED digital tube will display the function code and its contents corresponding to the fault. The fault relay will operate and the inverter will stop output. If the motor is rotating, it will stop freely until it stops rotating. The types of faults that may occur on the NE200 are shown in Table 11-1. When the inverter is faulty, the user should first check according to the prompts of the table, and record the fault phenomenon in detail. When technical service is required, please contact our after-sales service and technical support department or our agents.

Fault code	Type of faults	Possible fault reasons	Troubleshooting
E-01	Acc over current	Acc time is too short	Adjust acc time
		V/F curve setup is not suitable	Adjust V/F curve
		Restart the motor in running	Setup start mode as speed tracking restart
		Torque boost setup is too big	Adjust torque boost or set as auto mode
		Inverter capacity is too low	Select inverter with proper capacity
E-02	Dec over current	Dec time is too short	Adjust Dec time
		Potential load or load inertia is too big	Add suitable braking device
		Inverter capacity is too low	Select inverter with proper capacity
E-03	Over current at constant speed running	Load mutation	Check load
		Acc or Dec time is too short	Adjust Acc or Dec time
		Input voltage abnormal	Check input power supply
		Load abnormal	check load
		Inverter capacity is too low	Select inverter with proper capacity
E-04	Acc overvoltage	Input voltage abnormal	Check input power supply
		Acc time is too short	Adjust Acc time

Fault code	Type of faults	Possible fault reasons	Troubleshooting
		Restart the motor in running	Setup start mode as speed tracking restart
E-05	Dec overvoltage	Dec time is too short	Adjust the Dec time
		Potential load or load inertia is too big	Add suitable braking device
E-06	Overvoltage at constant speed running	Input voltage abnormal	Check input power supply
		Acc or Dec time is too short	Adjust the Acc or Dec time
		Abnormal change of input voltage	Mount input reactor
		Load inertia is too big	Add suitable braking device
E-07	Overvoltage of control power supply	Input voltage abnormal	Check input power supply
E-08	Inverter overheat	Air duct obstruction	Clean air duct
		Environment temperature is too high	Improve the ventilation or decrease the carrier frequency
		Fan damaged	Replace a new fan
		Inverter module abnormal	Contact supplier
E-09	Inverter overload	Acc time is too short	Adjust Acc time
		DC braking value is too high	Decrease DC braking current and increase braking time
		V/F curve setup is not suitable	Adjust V/F curve
		Restart the motor in running	Setup start mode as speed tracking restart
		Mains voltage is too low	Check mains voltage
		Too heavy load	Select inverter with proper capacity
E-10	Motor overload	V/F curve setup is not suitable	Adjust V/F curve
		Mains voltage is too low	Check mains voltage
		General motor runs at low speed with heavy load for long term	Use a special motor for long term running
		Wrong setting of motor overload protection factor	Set the factor right

Fault code	Type of faults	Possible fault reasons	Troubleshooting
		Motor chocked or sudden change of load	Check load
E-11	Under voltage in running	Mains voltage is too low	Check mains voltage
E-12	Inverter module protection	Inverter over current	Refer to over current troubleshooting
		Output 3-phase fault or ground short	Re-wiring
		Air duct obstruction or fan damaged	Clean air duct or replace a new fan
		Environment temperature too high	Decrease environment temperature
		Control board connecting wire or plug-in unit loose	Check and re-wiring
		Current waveform abnormal due to output missing phase, etc.	Check wiring
		Auxiliary power damaged, or driving voltage under voltage	Contact supplier
		Control board abnormality	Contact supplier
E-13	Peripheral fault	Close external fault terminals	Check the reason
E-14	Current detecting circuit fault	Loose wiring or terminal connections	Check and re-wiring
		Auxiliary power source damaged	Contact supplier
		Hall component damaged	Contact supplier
		Abnormal amplifier circuit	Contact supplier
E-15	RS232/485 Communication fault	Wrong baud rate setting	Set baud rate properly
		Serial port communication fault	Press  Key to reset or contact supplier
		Improper fault alarm parameter setting	Revise function code P3.09~P3.12
		Upper computer doesn't work	Check upper computer and connecting cable
E-16	System interference	Serious interference	Press  key to reset or install input power source filter

Fault code	Type of faults	Possible fault reasons	Troubleshooting
		DSP read/write error	Reset or contact supplier
E-17	EP2PPROM error	Read/write error of control parameter	press  key to reset or install input power source filter
E-18	Motor parameter over current fault	Power range of Motor and inverter do not match	Contact supplier press  key to reset
E-19	Input phase loss protection	One of R, S, T port has no voltage	Press  key to reset check voltage of R, S, T
E-20	over current fault when restart	Over current when inverter restart and check speed	press  key to reset adjust relevant parameters
E-31	PID feedback disconnected failure	PID external signal feedback disconnected	Check external wiring and signals
E-53	Pump water shortage protection failure	Water pump idling protection	Check the pump for water shortage or check Whether P9.04 / P9.06 related parameter settings are appropriate

11.2 Fault Record Query

This series inverter record the fault codes occurred in the last 6times and inverter running parameter when last fault occurred. The fault information is saved in P6 group.

12. Serial Port RS485 Communication Protocol

12.1 Communication Overview

The company's series of inverters provide users with a common RS485 communication interface for industrial control. The communication protocol adopts the MODBUS standard communication protocol. The inverter can be used as a slave to communicate with the host computer (such as PLC controller and PC) with the same communication interface and using the same communication protocol to realize centralized monitoring of the inverter. Can use a frequency converter as The host computer connects several inverters of the company as slaves through the RS485 interface. To achieve multi-machine linkage of the inverter. The remote control keyboard can also be connected through the communication port. Realize the user's remote operation of the inverter.

The MODBUS communication protocol of this inverter supports the RTU mode. The following is a detailed description of the inverter communication protocol.

12.2 Communication Protocol Description

12.2.1 Communication Network Mode

(1) The inverter acts as a slave network:

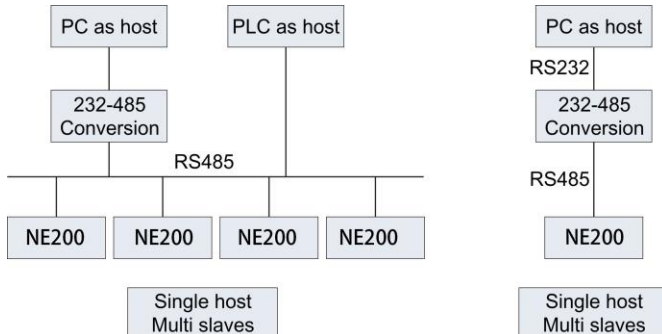

Figure 12-1 Schematic diagram of the unit network

(2) Multi-machine linkage networking mode:

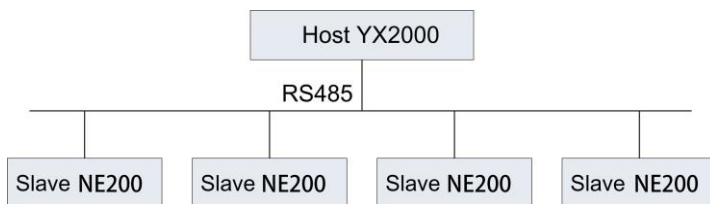

Figure 12-2 Schematic diagram of multi-machine linkage networking

12.2.2 Communication protocol mode

The inverter can be used as a host or as a slave in the RS485 network. When used as a master, it can control other inverters of the company to achieve multi-level linkage. When used as a slave, the PC or PLC can be used as a host. Control the inverter to work. The specific communication methods are as follows:

- ◆ The inverter is a slave, master-slave point-to-point communication. When the host sends a command using the broadcast address, the slave does not answer.
- ◆ As the host, the inverter uses the broadcast address to send commands to the slave, and the slave does not answer.
- ◆ The user can set the local address, baud rate and data format of the inverter by keyboard or serial communication.
- ◆ The slave reports the current fault information in the response frame of the last polling of the host.

12.2.3 Communication interface mode

Communication is RS485 interface, asynchronous serial, half duplex transmission. The default communication protocol mode uses RTU mode.

The default data format is: 1 bit start bit, 8 data bits, 2 stop bits, no check.

The default rate is 9600bps. For the communication parameter settings, see PC.00~PC.05 function code.

12.3 Communication protocol

Character structure:

10-character box (For ASCII)

(1-7-2 format, no parity)

Start bit	BIT 0	BIT1	BIT2	BIT3	BIT4	BIT5	BIT6	BIT7	Stop bit	Stop bit
-----------	-------	------	------	------	------	------	------	------	----------	----------

(1-7-1 format, Odd parity)

Start bit	BIT 0	BIT1	BIT2	BIT3	BIT4	BIT5	BIT6	BIT7	Odd parity	Stop bit
-----------	-------	------	------	------	------	------	------	------	------------	----------

(1-7-1 format, Even parity)

Start bit	BIT 0	BIT1	BIT2	BIT3	BIT4	BIT5	BIT6	BIT7	Even parity	Stop bit
-----------	-------	------	------	------	------	------	------	------	-------------	----------

11-character box (For RTU)

(1-8-2 format, no parity)

Start bit	BIT 0	BIT1	BIT2	BIT3	BIT4	BIT5	BIT6	BIT7	Stop bit	Stop bit
-----------	-------	------	------	------	------	------	------	------	----------	----------

(1-8-1 format, Odd parity)

Start bit	BIT 0	BIT1	BIT2	BIT3	BIT4	BIT5	BIT6	BIT7	Odd parity	Stop bit
-----------	-------	------	------	------	------	------	------	------	------------	----------

(1-8-1 format, Even parity)

Start bit	BIT 0	BIT1	BIT2	BIT3	BIT4	BIT5	BIT6	BIT7	Even parity	Stop bit
-----------	-------	------	------	------	------	------	------	------	-------------	----------

Communications data structures

ASCII mode

Frame header	Start character=": " (3AH)
Address Hi	Address: 8-bit address combined with two ASCII code

Frame header	Start character=":" (3AH)
Address Lo	
Function Hi	Function code:
Function Lo	8-bit address combined with two ASCII code
DATA (n - 1)	Data content:
.....	n * 8-bit data content combined with 2 * n ASCII code, in which high in front and low in post, n <= 4, 8 ASCII code as maximum
DATA 0	
LRC CHK Hi	LRC Check code:
LRC CHK Lo	8 check code combined with two ASCII code
END Hi	End character:
END Lo	END Hi = CR(0DH), END Lo = CR(0AH)

RTU mode:

START	Keep no input signal greater than or equal to 10ms
Address	Mailing address: 8-bit binary address
Command	Function code: 8-bit binary address
DATA (n - 1)	
.....	Data content: N*8-bit data, N<=8, maximum 8 bytes
DATA 0	
CRC CHK Low	CRC check code
CRC CHK High	16-bit CRC is composed of 2 8-bit binary combinations
END	Keep no input signal greater than or equal to 10ms

Address:

00H: All broadcast from inverters

01H: Communication with inverter of 01 address

0FH: Communication with inverter of 15 address

10H: Communication with inverter of 15 address, and so on, maximum to 254 (FEH)。

Function and DATA code:

03H: Read data from a register

06H: Write data to the register.

08H: Loop detection.

Function code 03H: Read data from a register:

For example: read data from the address 2104H of register (Output current)

ASCII mode:

Asking for information string format		Answering information string format	
Header	": "----3AH	Header	": "----3AH
Address	"0"----30H	Address	"0"----30H
	"1"----31H		"1"----31H
Function code	"0"----30H	Function code	"0"----30H
	"3"----33H		"3"----33H
content	"2"----32H	Information number	"0"----30H
	"1"----31H		"2"----32H
	"0"----30H		"0"----30H
	"4"----34H	Content of address 2104H	"0"----30H
			"0"----30H
			"0"----30H
			"0"----30H
LRC CHECK	"D" ----44H	LRC CHECK	"D" ----44H
	"7" ----37H		"7" ----37H
END	CR ----0DH	END	CR ----0DH
	LF ----0AH		LF ----0AH

RTU mode:

Asking for information string format		Answering information string format	
Address	01H	address	01H
Function code	03H	Function code	03H
content	21H	Information number	02H
	04H	content	00H
			00H
CRC CHECK Low	E8H	CRC CHECK Low	0EH
CRC CHECK High	4BH	CRC CHECK High	37H

Function code 06H: Write to register

For example: writing function code P0.02=50.00HZ to inverter address 01H.

ASCII mode:

Asking for information string format		Answering information string format	
Header	": "----3AH	Header	": "----3AH
Address	"0"----30H	Address	"0"----30H
	"1"----31H		"1"----31H
Function code	"0"----30H	Function code	"0"----30H
	"6"----36H		"6"----36H
content	"0"----30H	content	"0"----30H
	"0"----30H		"0"----30H
	"0"----30H		"0"----30H
	"2"----32H		"2"----32H
	"1"----31H	Data of address 2104H	"1"----31H
	"3"----33H		"3"----33H
	"8"----38H		"8"----38H
	"8"----38H		"8"----38H
LRC CHECK	"5" ----35H	LRC CHECK	"5" ----35H
	"C" ----43H		"C" ----43H
END	CR ----0DH	END	CR ----0DH
	LF ----0AH		LF ----0AH

RTU mode:

Asking for information string format		Answering information string format	
Address	00H	Address	01H
Function code	06H	Function	code
Content	00H	Content	00H
	02H		02H
	13H		13H
	88H		88H
CRC CHECK Low	25H	CRC CHECK Low	25H
CRC CHECK High	5CH	CRC CHECK High	5CH

Function code: 08H Communication loop test

This command is used to test the communication between main control equipment and inverter. Inverter receives and sends back the message to the main control equipment.

Asking for information string format		Answering information string format	
header	": "----3AH	Header	": "----3AH
Address	"0"----30H	Address	"0"----30H
	"1"----31H		"1"----31H
Function code	"0"----30H	Function code	"0"----30H
	"8"----38H		"8"----38H
content	"0"----30H	content	"0"----30H
	"1"----31H		"1"----31H
	"0"----30H		"0"----30H
	"2"----32H		"2"----32H
	"0"----30H	Data from address 2104H	"0"----30H
	"3"----33H		"3"----33H
	"0"----30H		"0"----30H
LRC CHECK	"4"----34H	LRC CHECK	"4"----34H
	"E" ----45H		"E" ----45H
END	"D" ----44H	END	"D" ----44H
	CR ----0DH		CR ----0DH
	LF ----0AH		LF ----0AH

RTU mode:

Asking for information string format		Answering information string format	
Address	01H	Address	01H
Function code	08H	Function code	08H
Content	01H	content	01H
	02H		02H
	03H		03H
	04H		04H
CRC CHECK Low	41H	CRC CHECK Low	41H
CRC CHECK High	04H	CRC CHECK High	04H

Check code:**ASCII mode:** Double byte ASCII code**Calculation method:**

For message sending end, the calculation of LRC is the method of continuous

accumulation the byte from "slave address" to "running data" which is not converted to ASCII code, discarding carry-over, reversing the 8 bit data, then plus 1 (converting to complement), finally converted to ASCII code, putting into the checkout area, high byte in front, low byte in post. For The message receiving end, the same LRC method is used to calculating checksum of received data, and comparing it with the received checksum. If they are equal, the message received is correct. If not equal, the received message is wrong. If error, the message frame is discarded with no answering, while the end continuing to receive the next frame data.

RTU mode: two bytes of 16 hex

The CRC domain is two bytes, including a binary value of 16 bits. It is calculated and added to the message by the sending end; while low byte added in front, and high byte added in post then, so the high byte of CRC is the last of the message. The receiving device re-calculates the CRC of the message, and compares it with the CRC in receiving domain, if the two values are different, it means there is error in received message, and the message frame is discarded, while there is no responding but waiting for the next frame data. CRC checksum calculation method reference to MODBUS protocol specification.

Communication protocol parameter definition

definition	Parameter address	Function description
Internal setting parameters	GGnnH	GG means parameter group, nn means parameter number
Commands to inverter (06H)	2000H	0001H: RUN
		0002H: FWD
		0003H: REV
		0004H: JOG
		0005H: FWD JOG
		0006H: REV JOG
		0007H: DEC and STOP
		0008H: STOP
		0009H: JOG STOP
		000AH: RESET
	2001H	Freq. setting

definition	Parameter address	Function description
Monitoring inverter (03H)	2100H	Read ERROR code
	2101H	State of inverter
		BIT0: STOP sign, 0: STOP; 1: RUN
		BIT1: Under voltage sign,1: Under voltage; 0: Normal
		BIT2:FWD REV sign,1: REV; 0: FWD
		BIT3:JOG sign,1: JOG; 0: NON JOG.
		BIT4:Close loop control, 1: Close; 0: Non close
		BIT5: swing freq. sign, 1: swing; 0: non swing.
		BIT6:PLC run sign, 1: PLC run, 0: non PLC
		BIT7:terminal multi-stage speed, 1: multi-stage 0: non multi-stage
		BIT8:normal running, 1: normal; 0: non.
		BIT9:Freq. from comm., 1: yes; 0: no.
		BIT10:Freq. from analog input, 1: yes; 0: no.
		BIT11:run commands from comm., 1: yes; 0: no.
BIT12: parameter password protection , 1: yes; 0: no.		
	2102H	Read Freq. setting
	2103H	Read output Freq.
	2104H	Read output current
	2105H	Read bus voltage
	2106H	Read output voltage
	2107H	Read motor speed
	2108H	Read module temp.
	2109H	Read VI analog input
	210AH	Read CI analog input
	210BH	Read software version

definition	Parameter address	Function description
Read function code (03H)	GGnnH (GG: function code number. nn :function code number)	Responding function code
Read function code (06H)	GGnnH (GG: function code number. nn :function code number)	Function code writing into inverter

Error code:

Error code	Description
01H	Function code error. it can not be identified: 03H, 06H, 08H.
02H	Address error. it can not be identified
03H	Data error. Data overrun

